

0.050 FC

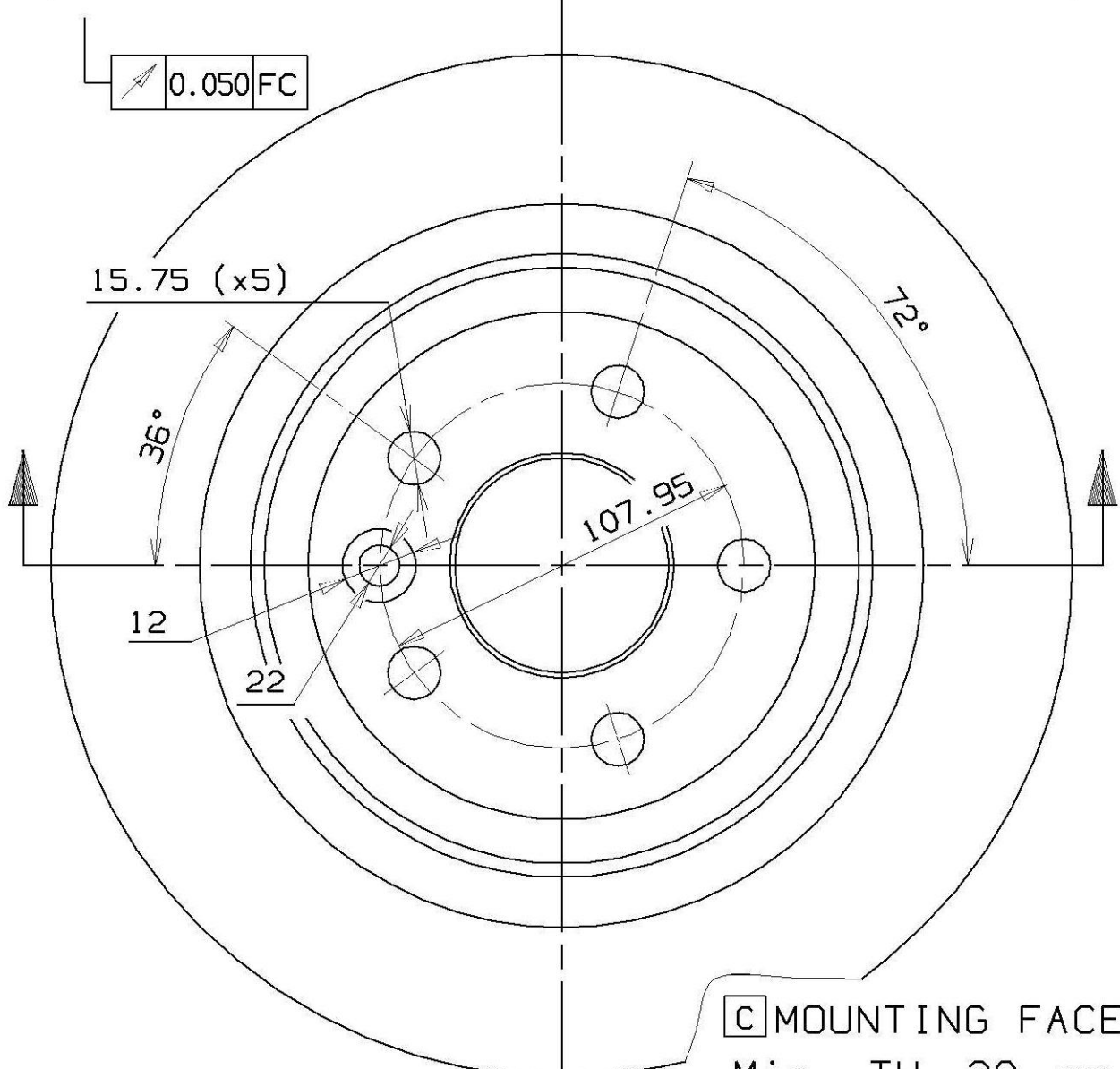

C MOUNTING FACE
 Min. TH 20 mm
 Weight 6.6 Kg

Type DA